

## SPECIFICATIONS

		PETROL	DIESEL		
<b>ENGINE</b>	Type	4 Cylinder 16V, DOHC	4 Cylinder 8V, SOHC, D-4D		
	Size	1496 cc (cm <sup>3</sup> )	1364 cc (cm <sup>3</sup> )		
	Max. Power	66KW (90 PS) @ 5600 rpm	50KW (68 PS) @ 3800 rpm		
	Max. Torque	132 Nm (13.46 kg-m) @ 3000 rpm	170 Nm (17.3 kg-m) @ 1800-2400 rpm		
	Fuel Supply System	Electronic Fuel Injection (EFI)	Common Rail Direct Injection		
	Mileage	16.78 kmpl <sup>1</sup>	23.59 kmpl <sup>1</sup>		
<b>TRANSMISSION</b>	Type	5 Speed Manual	5 Speed Manual		
<b>SUSPENSION</b>	Front	MacPherson Strut	MacPherson Strut		
	Rear	Torsion Beam	Torsion Beam		
<b>BRAKES</b>	Front	Ventilated Disc	Ventilated Disc		
	Rear	Drum	Drum		
<b>DIMENSIONS</b>	Overall Length X Width X Height	4265 mm x 1695 mm x 1510 mm	4265 mm x 1695 mm x 1510 mm		
	Wheelbase	2550 mm	2550 mm		
	Ground Clearance	174mm	174 mm		
	Fuel Tank Capacity	45 Litres	45 Litres		
	Turning Circle Radius	4.9 m	4.9 m		
	Boot Space	0.595 m <sup>3</sup> (595 Litres)	0.595 m <sup>3</sup> (595 Litres)		
	Tyre	185/60 R15 (Tubeless)	185/60 R15 (Tubeless)		
	Kerb Weight	1-920 kg/G-935 kg/V-945 kg	JD-995 kg/GD-1015 kg/VD-1020 kg		
<b>GRADE</b>		<b>I/ID</b>	<b>G/GD</b>	<b>V/VD</b>	
<b>EXTERIOR</b>	Front Grille	Matt Black	Single Chrome	Double Chrome	
	Body Coloured Bumpers	✓	✓	✓	
	Front Fog Lamps	×	×	✓	
	Body Coloured Door Handles	×	✓	✓	
	Body Coloured ORVM	×	✓	w/Turn Indicator	
	Side Protection Moulding w/Chrome Insert	×	✓	✓	
	B Pillar Black Out	×	✓	✓	
	Intermittent Wiper	×	✓	✓	
	Full Wheel Caps	×	✓	×	
	12 Spoke Alloy Wheels (4)	×	×	✓	
	Roof Mounted Antenna (Foldable)	×	✓	✓	
	Chrome Garnish on Boot	×	✓	✓	
	<b>COMFORT &amp; CONVENIENCE</b>	Air Conditioner with Heater & Clean Air Filter	✓	✓	✓
	Power Windows with Driver Side Auto-down	×	✓	✓	
Electric Power Steering w/Tilt Function	✓	✓	✓		
Central Locking	×	✓	✓		

		I/ID	G/GD	V/VD
<b>GRADE</b>	Cooled Glove Box	✓	✓	✓
	Front Cabin Lights	✓	✓	✓
	Front Power Outlet (12V)	×	✓	✓
	Adjustable Front Headrest	×	✓	✓
	Pillow Type Rear Headrest	×	✓	✓
	Height Adjustable Driver Seat	×	✓	✓
	Rear Defogger	×	×	✓
	Tachometer	×	×	✓
	Digital Tripmeter	✓	✓	✓
	Audio System (w/Remote)	×	2 DIN 1CD MP3 AM/FM w/USB	2 DIN 1CD MP3 AM/FM w/USB, Aux-in & Bluetooth
	Speakers	×	4	4
	Audio Controls on Steering Wheel	×	×	Opt
	Internally Adjustable ORVM	✓	✓	✓
	<b>INTERIOR</b>	Dark Grey Interiors	✓	✓
Two-tone Premium Interiors	×	Opt	✓	
Fabric Insert Door Trim	×	Opt	✓	
3 Spoke Steering Wheel	✓	✓	✓ (Sporty Leather Wrapped - Opt)	
Silver Accent on Steering Wheel	×	Opt	✓	
7 Bottle Holders (1 Litre)	✓	✓	✓	
Front & Rear Door Pockets	✓	✓	✓	
Day/Night Inside Rear View Mirror	✓	✓	✓	
Driver & Passenger Sunvisor	✓	✓ (P Side Mirror)	✓ (P Side Mirror)	
Chrome Accented Shift Knob	×	Opt	✓	
Assist Grip with Coat Hook	1	3	3	
Wood Grain Finish on Door Armrest	×	×	✓	
Remote Fuel Lid & Tailgate Opener	✓	✓	✓	
<b>SAFETY &amp; SECURITY</b>	Dual SRS Airbags (D+P) & Driver Seatbelt Warning	×	Opt	Opt
ABS with EBD	×	Opt	Opt	
Immobiliser	✓	✓	✓	
Keyless Entry	×	✓	✓	
Door Ajar Warning	✓	✓	✓	

<sup>1</sup>As certified by Test Agency under rule 115 of CMVR, 1989 under standard test conditions. Actual mileage on road may vary. Opt - Available as part of Safety Package.



Classic Grey



Symphony Silver



Celestial Black



White



Vermillion Red

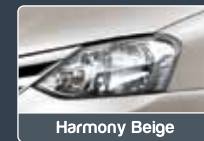

Harmony Beige

Log on to [pointart.mobi](http://pointart.mobi) from your mobile browser to download PointART. Capture Toyota logo & experience Toyota's products & services.



**UNMATCHED WARRANTY\***  
3 years / 1,00,000kms  
\*Conditions Apply

For more info, visit [www.toyotabharat.com](http://www.toyotabharat.com), Talk to Toyota at 1800-425-0001 (BSNL/MTNL Toll Free No.) or +91-80-66293001 (Direct No.)  
Note: Vehicles pictured and specifications detailed in this brochure may vary between models and equipment. Addition of extra features may change figures in this chart. Toyota Kirloskar Motor Pvt. Ltd. reserves the right to alter any details of specifications and equipment without notice. Actual colour of vehicle body & upholstery might differ slightly from the images depicted in this brochure. Features are grade specific.

is your Etios dealer



[www.toyotaetios.in](http://www.toyotaetios.in)

# THE NEW TOYOTA ETIOS WHEN WINNING IS A HABIT



**NEW  
ETIOS**

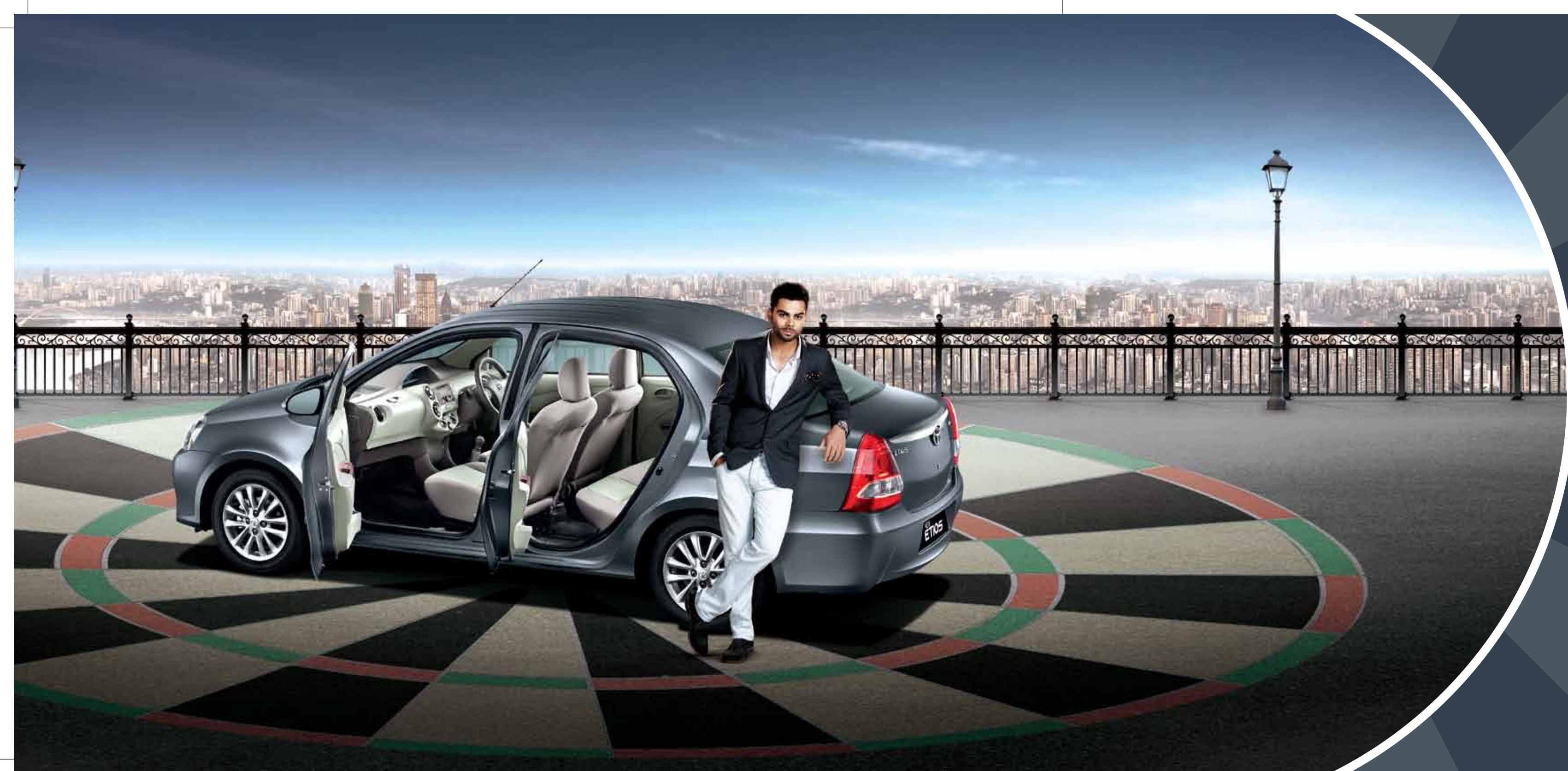

## THOSE WHO WIN, DO IT EVERY DAY.

Every winner knows there's only one way to achieve victory. By going out there and giving it your best. Day, after day, after day. With grit, determination, confidence and style. That's the kind of winning performance you'll come to appreciate in the new Toyota Etios.



### 2 Tone Premium Interiors

The wonderful Ash Brown interiors with new textures, fabric and classy wood-finish door trims spell a new way to savour victory.



### 2 Din Audio with Bluetooth, USB, Aux-In and Remote

Bluetooth. USB. CD. Aux-In. Remote control. Just tune in to the sweet sounds of success.



### Comfortable New Seats

Height adjustable driver's seat, adjustable front head rests and integrated rear head rests. Flat rear floor is designed to give you Best-in-Class cabin space.



### Cooled 0.013m<sup>3</sup> (13L) Glove Box

Spacious enough for a trophy.

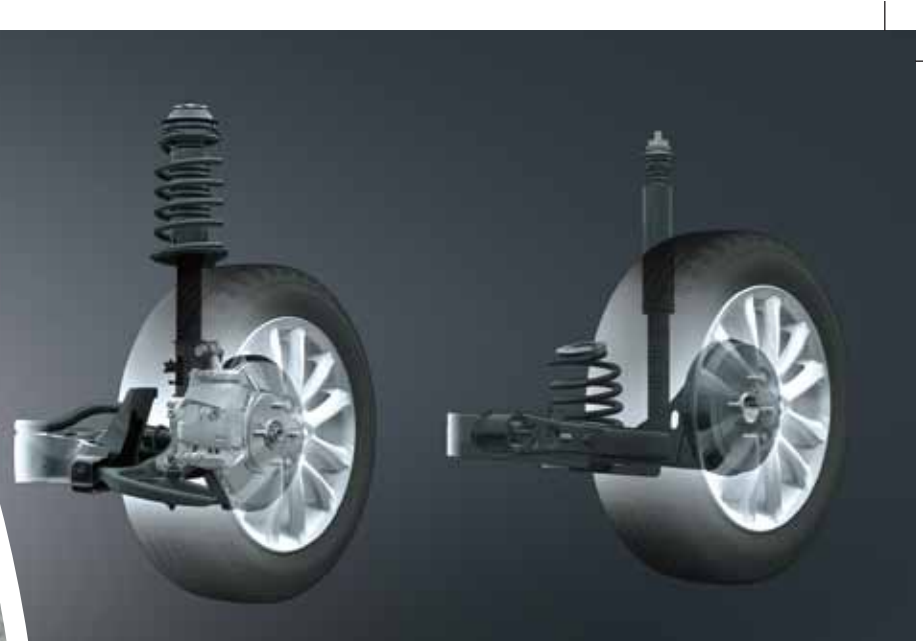

### Superb Suspension

Optimised front and rear suspension, for exceptional comfort and stability on the way to the winner's circle.



### Ergonomic Steering Wheel with EPS & Tilt

Sporty and well designed, with integrated audio controls make this a remarkable steering wheel. Electric Power Steering with tilt function, to steer your way easily to No. 1.

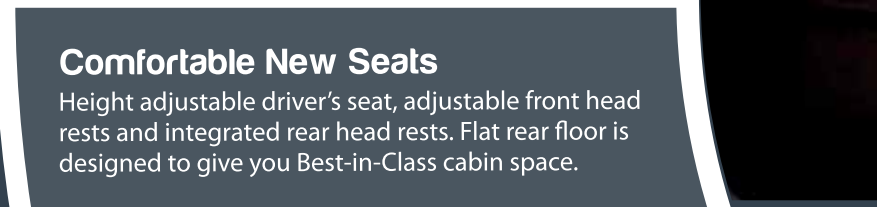

### 0.595m<sup>3</sup> (595L) Boot Space

Room enough to accommodate a life of victory, with easily accessible low loading height.



### AC with Clean-Air Filter

The cabin is silent and the AC comes with an air-purifying filter, powerful blowers and multi-directional vents, because a winner always keeps his cool.



## WIN WITH COMFORT

A winner is always at ease. Knowing full well what's needed to secure victory. And sure of having exactly what it takes. You'll find that this self-assurance is the very essence of the Etios.





MILEAGE  
**23.59\***  
kmpl

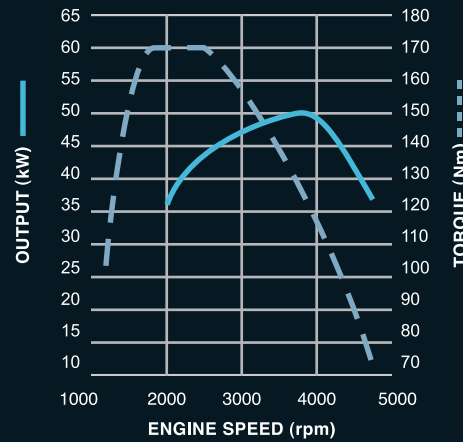

### 0.0014m<sup>3</sup> (1.4L) D-4D Diesel Engine

Generous torque from 1800 rpm for excellent initial and in-gear passing acceleration. The Intercooler ensures an ideal combination of excellent driving performance and unparalleled mileage. And everything else you could ask for in the victory lane.

### 0.0015m<sup>3</sup> (1.5L) DOHC Petrol Engine

Best-in-Class torque at 3000 rpm. Highly fuel-efficient. Lightweight. Lean engine construction design. Improved anti-knocking. Electronic throttle control. And a Toyota-first design that integrates the exhaust manifold with the cylinder head resulting in low emissions. All of which makes this a true winner.



MILEAGE  
**16.78\***  
kmpl

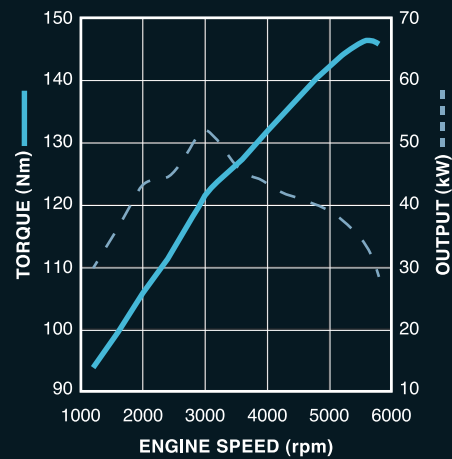

## PERFORMANCE IS THE KEY TO WINNING

Which means the need to perform constantly. Consistently. Reliably. Every single day. Which is just what you get in the new Etios – performance you can depend on.

## A TRUE WINNER PUTS SAFETY FIRST

After all, tomorrow brings another challenge. Another victory to be enjoyed. And the only way to do that, is to ensure you're safe and sound. Which is why the new Etios is fully equipped to protect you in every way.

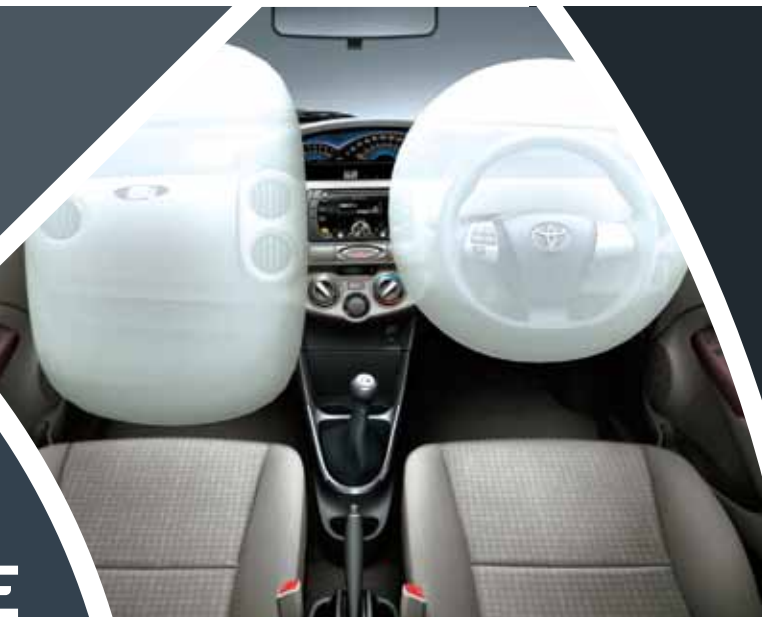

### Dual Front SRS Airbags

Designed to reduce the head and upper torso's impact on the steering wheel or the dash panel in case of a frontal collision on the road to victory.

### Impact Absorbing Body Structure

Absorbs impact across the body to keep the cabin intact and provide maximum protection for all on board. Keeping your loved ones safe, to share your triumphs.

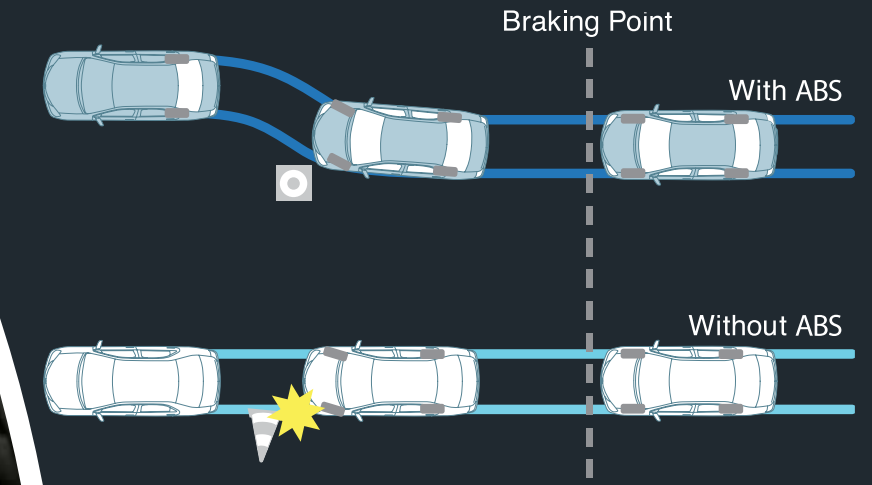

### ABS with EBD

Anti-lock Braking System with EBD ensures complete vehicle control and a smooth stop while braking suddenly. Because winning demands complete control.

### Combimeter with New Blue Illumination

The combimeter with new blue illumination ensures the driver needn't look away from the road for too long, for a safe drive. Designed to help you beat the odds.





## ALL THE STYLE OF A WINNER

There's always an aura about a winner. An air of confidence and success. And you'll find it expressed in every inch of the new Etios. From the stunning new front grille, to the sleek new interiors.



### 12 Spoke Alloys

Command attention with these stylish 12 spoke alloys.



### Bold New Front Grille

Confident new design with a superb chrome finish that's bound to win admiration.



### New Side Mirrors with Indicators

Elegantly incorporating turn signals, the new side mirrors make a bold statement.

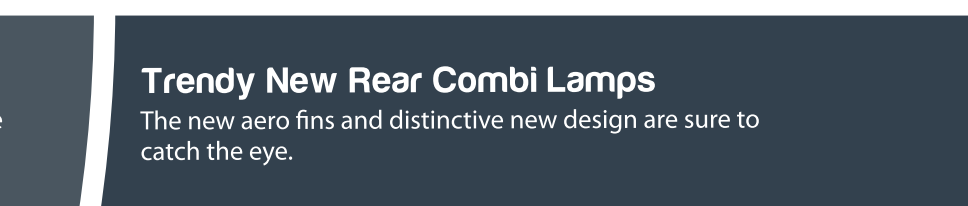

### Trendy New Rear Combi Lamps

The new aero fins and distinctive new design are sure to catch the eye.





**Accessories shown:**

Front Bumper Spoiler | Radiator Chrome Grille | Headlamp Chrome Garnish | Fog Lamp | Outside Rearview Mirror  
Chrome Cover | Door Side Visor with Chrome | Side Skirt | Trunk Spoiler

**Accessories shown:**

Rear Bumper Spoiler | Rear Lamp Chrome Garnish | Reverse Parking Sensor | Door Side Visor with Chrome | Side Skirt  
Fuel Lid Graphics | Rear Door Garnish | Trunk Spoiler



Accessories shown are not a part of standard fitment.



**Gear Knob with Wood-like Garnish  
& Shift Boot Chrome Bezel**

## THE MARK OF A WINNER

**Leg Room Lamp**

